

# MIRROR

**Britax**



Automotive Equipment

## **MIRROR** Product Catalogue Edition 10.1





# Britax Automotive Equipment

# MIRROR

Product Catalogue Edition 10.1

## In this edition:

### NEW Britax Electric Mirrors

The new electric mirrors from Britax are heavy duty and ready for work. They come in two sizes and feature split glass with heaters in both. The main glass is electrically adjustable while the smaller convex spotter is adjustable manually.  
**Page M8**



### Britax Acrylic Lens Mirrors

The acrylic lens range of Britax mirrors are tough and shatterproof. Even when subjected to harsh vibration or shock—including a direct strike to the reflector's surface, these mirrors will not shatter or break. Even under extreme circumstances the mirror face may fracture or become deformed, but the mirror will still be usable. Ideal for extreme environments such as mining or agriculture.  
**Page M26**



### Britax Split/Two-piece Mirrors

Britax have a range of two piece mirrors—the advantage is having the best of both (flat and convex) neatly housed in a single mirror case. The large flat mirror gives excellent rearward vision while the smaller convex spotter helps with blind spots and assists when reversing or parking.  
**From Page M14**



### Range of Mirror Mounting Options

Britax have a wide range of arms and brackets to help mount any mirror in various applications. See the 'Mirror Arms and Brackets' section for a list of parts and options.  
**From Page M47**

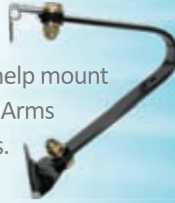

### Convex Mirrors Explained

Convex mirrors are all rated with a radius number (e.g. R1200). This is explained at the beginning of the mirror listings.  
**Page M6**

### Mirror Selection Chart

Not sure which mirror is right for your application? Check the comprehensive mirror selection chart at the back of this catalogue to compare and choose any mirror from the range. All the main specifications are listed along with the page number for each part.  
**Page M58**



The Britax Automotive Equipment aftermarket product catalogue series are all printed using FSC certified paper. The mission of FSC is to promote environmentally appropriate, socially beneficial and economically viable management of the world's forests. Its governance structure ensures the organisation is independent of any one interest group by requiring an equal balance in power between economic, social and environmental chambers. More than 80 million hectares of forest have been certified to FSC standards worldwide and more than 5,000 companies participate in the system.



**ABOUT BRITAX AUTOMOTIVE EQUIPMENT  
Aftermarket Division**

The PSE (Public Safety Equipment) Group has for over 50 years been one of the most innovative and successful manufacturing and marketing companies in the world for automotive emergency lighting. The PSE Group globally has five manufacturing operations with Code3, Kustom Signal and Lasercraft in the USA, and Britax PMG and Premier Hazard in the UK. The group also includes Britax Automotive Equipment and distribution operations in Germany and France.

Britax Automotive Equipment Australia commenced operation in 1992 and now employs over 30 people. Primarily an importer and distributor for the Australasian region of internationally recognised brand names, Britax products are synonymous with quality and value for money. Such brands in the Australian division include Britax beacons, Cole Hersee switches, GE and Tungstam globes, Code3 warning systems and Xray Vision lightware.



The Automotive Aftermarket sector specialises in warning lighting, general lighting, HID and LED lighting, globes, switches and control devices, connectors and a wide range of automotive mirrors. We cater for mining, agricultural, earthmoving, industrial, transport, 4WD, passenger car and marine applications with specialised electrical products for these various markets.

When it comes to a comprehensive range of quality automotive lighting and electrical solutions Britax is your first choice for range and value.

For our up-to-date product catalogue and the latest new product updates and information, visit the Britax website at [www.britaxae.com.au](http://www.britaxae.com.au)



Introduction to Britax Mirrors. . . . . M6  
 Introduction to Electric Mirrors . . . . . M7  
 Electric Mirror Heads. . . . . M8  
 West Coast Mirror Heads . . . . . M11  
 Split/Two-piece Mirror Heads. . . . . M14  
 Single Flat Mirror Heads . . . . . M17  
 Introduction to Acrylic Mirror Reflectors. . . . . M26  
 Single Convex Mirror Heads . . . . . M27  
 Spotters and Reversing Mirrors . . . . . M38  
 Light Commercial and 4WD Mirrors. . . . . M43  
 Towing Mirrors. . . . . M46  
 Mirror Arms and Brackets . . . . . M47  
 Mirror Wiring Kits and Heaters. . . . . M55  
**Mirror Selection Chart . . . . . M58**



# MIRRORS GLASS REFLECTORS

Britax is the number one commercial mirror brand in Australia. Britax mirrors feature superior quality and product innovation. Britax offer an extensive range of fitments with adjustable brackets plus a range of stick-on or bolt mount spotter mirrors. The mirror range covers a massive range of applications from commercial to light commercial, passenger vehicles to 4WD, and agricultural to construction equipment.

The range includes both flat and convex mirror reflectors in various shapes and combinations. See the diagram below to better understand the radius number associated with convex mirrors:



## Britax Convex Mirrors

Britax convex mirrors are curved to different degrees using a radius number—the sharper the curve, the wider the angle of vision:

e.g. a 300mm height R1200 mirror appears only slightly curved as it's a section of a larger theoretical circle

**R = Radius (spherical)**  
e.g. R400 = a 400mm radius

R1800 is the least curved mirror (bigger number, less curve)  
R400 is the most curved mirror (smaller number, more curve)

This conforms to the EEC Directive 88/321 and ECE Regulation 46.01

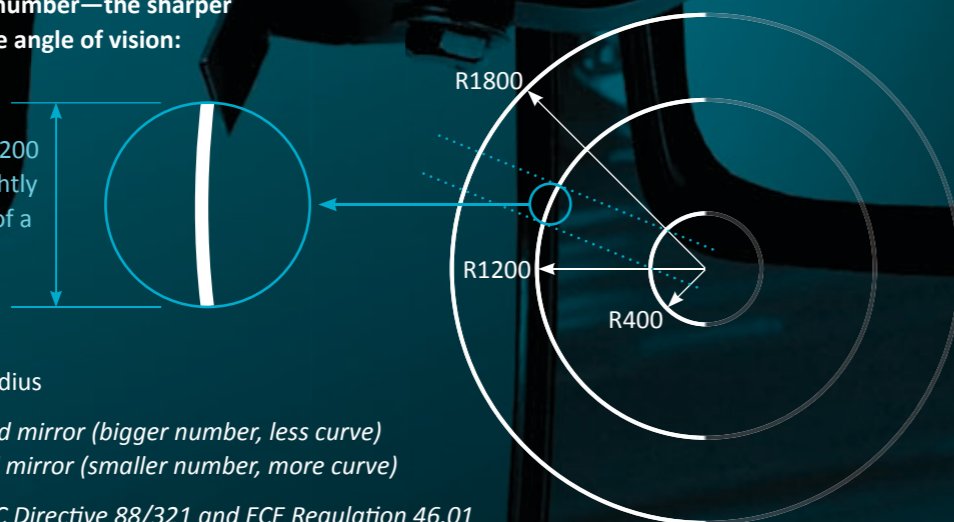

## Britax Universal Heated Electric Split Mirrors

### Make mirror adjustment faster, safer and more flexible

The Britax range of universal electric mirrors are high in quality and features, providing a heated electric mirror solution for European, Japanese, American and Australian vehicles.

The two piece split mirror design gives the optimum rear viewing capability with the main glass being flat to ensure distortion-free vision while on the road. The smaller section is a convex mirror that allows additional field of vision which is particularly handy for eliminating blind spots and is also helpful when reversing and parking.

The flat top glass adjusts using an electric controller, allowing the driver to adjust and set mirrors from the driving position. The lower convex glass is adjustable manually as this type of mirror is 'set and forget', and features a radius number of R400. Both the top and lower glass are heated and are available in 12 or 24 volt versions. Two sizes are available and both universally fit brackets of 19mm, 22mm and 28mm diameter. Both mirrors have central mounting points for left or right side fitment, and both are E compliant and legal for use on Australian roads.

A control switch and harness are sold separately (147HARNES). The harness has 1.5 metres of wiring per side and the combo will suit two mirrors.

**Dimensions for the smaller mirror:**  
H 420mm x W 190mm x D 75mm

**Dimensions for the larger mirror:**  
H 480mm x W 210mm x D 125mm

These electric mirrors are universally useful, however they are particularly suited to the following vehicles and conditions:

- Vehicles that experience changing or varied conditions, and also vehicles that change driver on a regular basis
- Dual control vehicles (left and right hand drive) such as street sweepers or waste management vehicles
- Articulated vehicles such as cranes that are difficult to maneuver and are often in tight spaces—requiring a wide viewing range depending on operation
- Also suitable for use on prime movers, trucks, council vehicles, agricultural machinery, and many other applications



**147420SEKIT12**

**PLASTIC SPLIT 12V ELECTRIC R400 H420 HEATED KIT**



**420 Split Electric KIT | Electric Mirror Heads**

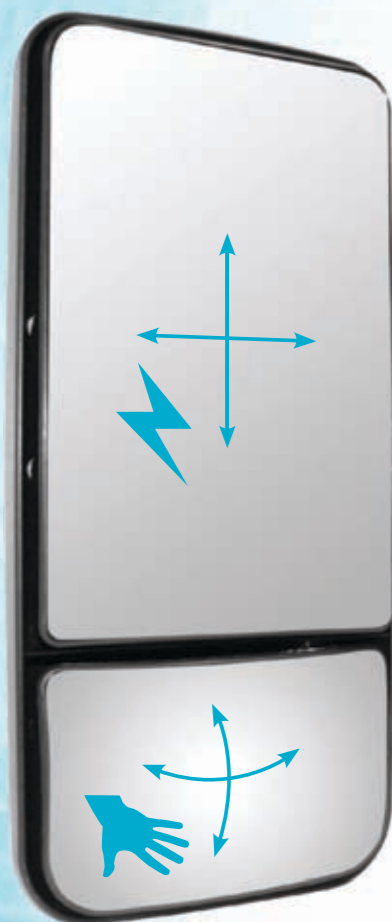

- Kit 2 x mirrors + Switch
- Clamp suits 19 - 28mm
- 12V
- Electric flat mirror
- Manual R400 spotter

**Features:**

- Universal LH or RH Split Electric mirror
- Suits European, Japanese, American & Australian vehicles
- Electric flat mirror head heated
- Manual Spotter mirror heated
- Universal clamp suits 19-28mm arm with 2 x adaptor clamps provided
- 4 wire electric actuator, Ylw+Blk & Blu+Bwn
- Heater requires separate switch, Rd+Rd/Gn, 1.5m harness fitted

**Dimensions:**

H 420mm x D 75mm x W 190mm

Alternate Part Numbers:  
Single Mirror . . . . 147420SE12H  
24V Version . . . . 147420SEKIT24

Spare Part Numbers:  
147420FG12H . . . Glass 12V Heated  
147420ACT12 . . . 12V Electric Actuator  
147HARNES . . . . Switch 2 Way & Harness  
58326-24 . . . . . Dual Heater Switch  
1470015 . . . . . W/Coast 15" Adpt Tube  
1470016 . . . . . W/Coast 16" Adpt Tube  
1470018 . . . . . W/Coast 18" Adpt Tube

Approvals:  
E Approved, ADR 14-00



Right or left side universal mounting 19mm, 22mm, 28mm



**147420SEKIT24**

**PLASTIC SPLIT 24V ELECTRIC R400 H420 HEATED KIT**



**420 Split Electric KIT | Electric Mirror Heads**

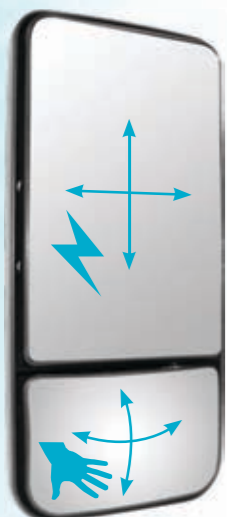

- Kit 2 x mirrors + Switch
- Clamp suits 19 - 28mm
- 24V
- Electric flat mirror
- Manual R400 spotter

**Dimensions:**

H 420mm x D 75mm x W 190mm

Alternate Part Numbers:  
Single Mirror . . . . 147420SE24H  
12V Version . . . . 147420SEKIT12

Spare Part Numbers:  
147420FG24H . . . Glass 24V Heated  
147420ACT24 . . . 24V Electric Actuator  
147HARNES . . . . Switch 2 Way & Harness

Approvals:  
E Approved, ADR 14-00



**PLASTIC SPLIT 12V ELECTRIC R600 H480 HEATED KIT**

**147480SEKIT12**



**480 Split Electric KIT | Electric Mirror Heads**



Alternate Part Numbers:  
Single Mirror . . . . 147480SE12H  
24V Version . . . . 147480SEKIT24

Spare Part Numbers:  
147480FG12H . . . Glass 12V Heated  
147480ACT12 . . . 12V Electric Actuator  
147HARNES . . . . Switch 2 Way & Harness  
58326-24 . . . . . Dual Heater Switch  
1470016 . . . . . W/Coast 16" Adpt Tube  
1470018 . . . . . W/Coast 18" Adpt Tube

Approvals:  
E Compliant



- Kit 2 x mirrors + Switch
- Clamp suits 19 - 25mm
- 12V
- Electric flat mirror
- Manual R600 spotter

**Features:**

- Universal LH or RH Split Electric mirror
- Suits European, Japanese, American & Australian vehicles
- Electric flat mirror head heated
- Manual Spotter mirror heated
- Universal clamp suits 19-25mm arm
- 4 wire electric actuator
- Heater requires separate switch
- 1.5m harness fitted

**Dimensions:**

H 480mm x D 125mm x W 210mm



**PLASTIC SPLIT 24V ELECTRIC R600 H480 HEATED KIT**

**147480SEKIT24**



**480 Split Electric KIT | Electric Mirror Heads**



Alternate Part Numbers:  
Single Mirror . . . . 147480SE24H  
12V Version . . . . 147480SEKIT12

Spare Part Numbers:  
147480FG24H . . . Glass 24V Heated  
147480ACT24 . . . 24V Electric Actuator  
147HARNES . . . . Switch 2 Way & Harness

Approvals:  
E Compliant



- Kit 2 x mirrors + Switch
- Clamp suits 19 - 25mm
- 24V
- Electric flat mirror
- Manual R600 spotter

**Dimensions:**

H 480mm x D 125mm x W 210mm



**7132.509**

**PLASTIC CONVEX 24V ELECTRIC R1800 H328 W238**



**328 Electric Convex | Electric Mirror Heads**



- Left Hand or Right Hand
- Clamp suits 16-25mm
- 24V
- 0.5A Motor

**Features:**

- Plastic moulded mirror head

**Dimensions:**

H 328mm x D 120mm x W 238mm

Alternate Part Numbers:  
7132.508. . . . . 12V Version  
7132.511. . . . . 24V Heated  
7132.510. . . . . 12V Heated

**Spare Part Numbers:**

7418.006.05 . . . . Cnx Glass ( Pk 5 )  
7418.512.05 . . . . Cnx Glass 24V Heat  
7418.511.05 . . . . Cnx Glass 12V Heat  
147HARNESS . . . . Switch & Loom Twin

Approvals:  
E Approved, ADR 14-00

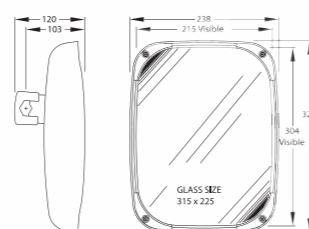

**1423190**

**PLASTIC FLAT 24V ELECTRIC H380 W190 M20 HEATED**



**380 Electric Flat Heated | Electric Mirror Heads**



- Left Hand or Right Hand
- Clamp suits 14-20mm arm
- 24V Heater
- 1.2A Heat & Motor
- 1A Heater

**Features:**

- Plastic moulded mirror head
- Universal clamp suits 14-20mm arm

**Dimensions:**

H 380mm x D 87mm x W 190mm

Alternate Part Numbers:  
12V Version . . . . 1423191

**Spare Part Numbers:**

1423390 . . . . . Flat Glass & Heater  
1423870 . . . . . Switch & Loom Single  
1423872 . . . . . Switch & Loom Twin

Approvals:  
E Approved, ADR 14-00

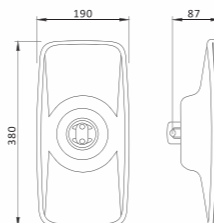

**STAINLESS STEEL H415 W188 M16"**



**16" Stainless Steel | West Coast Mirror Heads**

Spare Part Numbers:  
1422000 . . . . . Universal Bracket

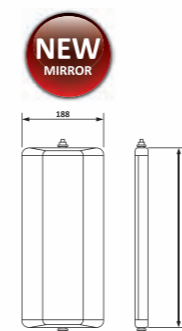

**Part Numbers:**

1421759 Stainless Steel Split H415 R600 W188 M16"  
1421758 Stainless Steel Flat H415 W188 M16"  
1421756C Stainless Steel Flat H415 M16" Marker Heater  
1421760C Stainless Steel Flat H415 M16" Marker

- Stainless steel body
- West Coast 16" x 7"

**Features:**

- West Coast style mirror head
- Stainless steel body and fittings
- Split mirror models include fixed spotter: R600

**Dimensions:**

H 415mm x D 40mm x W 188mm



**STAINLESS STEEL FLAT H463 W163 M18"**

**1422655**



**18" Flat Glass | West Coast Mirror Heads**

Spare Part Numbers:  
1422000 . . . . . Universal Bracket  
1423301 . . . . . Glass ( Pk 5 )

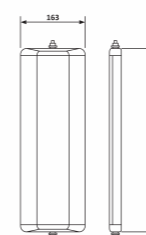

- Stainless steel housing
- West Coast 18"

**Features:**

- Unique extrusion to hold glass

**Dimensions:**

H 463mm x D 40mm x W 163mm



**1421101**

**STEEL FLAT H292 W163 M11"**

**1421101**



**11" Flat Glass | West Coast Mirror Heads**

Spare Part Numbers:  
1422000 . . . . . Universal Bracket  
1423305 . . . . . Glass ( Pk 5 )

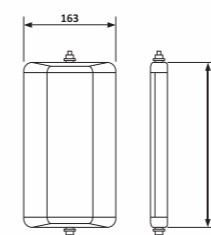

- Corrosion resistant black steel housing
- West Coast 11"

**Features:**

- Unique extrusion to hold glass

**Dimensions:**

H 292mm x D 40mm x W 163mm



**1421131**

**STEEL FLAT H379 W163 M14.6"**



**15" Flat Glass | West Coast Mirror Heads**

- Corrosion resistant black steel housing
- West Coast 14 5/8"

**Features:**

- Unique extrusion to hold glass

**Dimensions:**

H 379mm x D 40mm x W 163mm

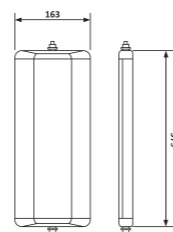

Spare Part Numbers:  
1422000 . . . . . Universal Bracket  
1423311 . . . . . Glass ( Pk 5 )

**1421106**

**STEEL FLAT H418 W163 M16"**



**16" Flat Glass | West Coast Mirror Heads**

- Corrosion resistant black steel housing
- West Coast 16"

**Features:**

- Unique extrusion to hold glass

**Dimensions:**

H 418mm x D 40mm x W 163mm

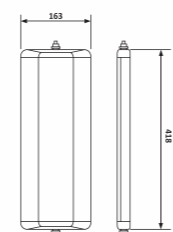

Spare Part Numbers:  
1422000 . . . . . Universal Bracket  
1423331 . . . . . Glass ( Pk 5 )

**1421100**

**STEEL FLAT H463 W163 M18"**



**18" Flat Glass | West Coast Mirror Heads**

- Corrosion resistant black steel housing
- West Coast 18"

**Features:**

- Unique extrusion to hold glass

**Dimensions:**

H 463mm x D 40mm x W 163mm

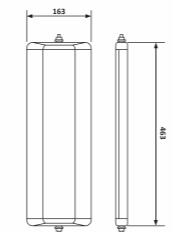

Spare Part Numbers:  
1422000 . . . . . Universal Bracket  
1423301 . . . . . Glass ( Pk 5 )  
1423529 . . . . . Rubber 422mm

**STEEL FLAT MARKER LIGHT H379 W163 M14.6"**

**1421133**



**15" Flat Glass | West Coast Mirror Heads**

Spare Part Numbers:  
1422000 . . . . . Universal Bracket  
1423311 . . . . . Glass ( Pk 5 )  
881-00-12V . . . . . Marker Light

- Corrosion resistant black steel housing
- West Coast 14 5/8" with marker lamp

**Features:**

- Unique extrusion to hold glass

**Dimensions:**

H 379mm x D 40mm x W 163mm

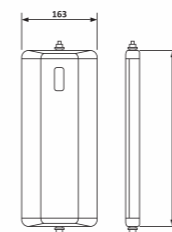

**STEEL FLAT MARKER LIGHT H418 W163 M16"**

**1421166**



**16" Flat Glass | West Coast Mirror Heads**

Spare Part Numbers:  
1422000 . . . . . Universal Bracket  
1423331 . . . . . Glass ( Pk 5 )  
881-00-12V . . . . . Marker Light

- Corrosion resistant black steel housing
- West Coast 16" with marker lamp

**Features:**

- Unique extrusion to hold glass

**Dimensions:**

H 418mm x D 40mm x W 163mm

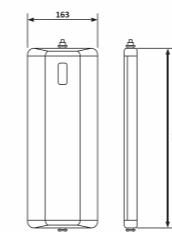

**STEEL FLAT MARKER LIGHT H463 W163 M18"**

**1421158**



**18" Flat Glass | West Coast Mirror Heads**

Spare Part Numbers:  
1422000 . . . . . Universal Bracket  
1423301 . . . . . Glass ( Pk 5 )  
881-00-12V . . . . . Marker Light

- Corrosion resistant black steel housing
- West Coast 18" with marker lamp

**Features:**

- Unique extrusion to hold glass

**Dimensions:**

H 463mm x D 40mm x W 163mm

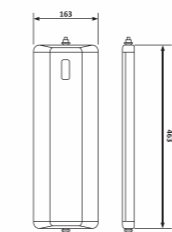

**147380SL12H**

**PLASTIC SPLIT H380 R500 HEATED LEFT**



**380 Split Flat & Convex | Split/Two-piece Mirror Heads**



- Flat top, R500 Spotter
- Suits 19mm tubular arm
- 12V Heater
- Left Hand

**Features:**

- Two-piece split mirror, Left hand mount
- Top glass flat, bottom glass convex
- Top glass adjusts with the whole mirror, bottom glass adjusts independently
- Fits Hino Dutro, Toyota, UD and many universal applications

**Dimensions:**

H 380mm x D 85mm x W 195mm

Alternate Part Numbers:  
24V Version . . . . . 147380SL24H  
Marker Version . . . 147380SL12MH  
**Right Hand . . . . . 147380SR12H**

Spare Part Numbers:  
147380SG . . . . . Flat Glass 380 Series  
1471022 . . . . . Mount suit 10-22mm  
1471625 . . . . . Mount suit 16-25mm

Approvals:  
Passenger LH side

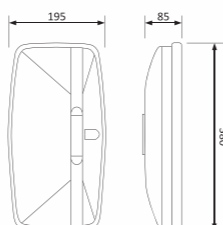

**147380SL**

**PLASTIC SPLIT H380 R500 LEFT**



**380 Split Flat & Convex | Split/Two-piece Mirror Heads**



- Flat top, R500 Spotter
- Suits 19mm tubular arm
- Left Hand

**Features:**

- Two-piece split mirror, left hand mount
- Top glass flat, bottom glass convex
- Top glass adjusts with the whole mirror, bottom glass adjusts independently
- Fits Hino Dutro, Toyota, UD and many universal applications

**Dimensions:**

H 380mm x D 85mm x W 195mm

Alternate Part Numbers:  
**Right Hand . . . . . 147380SR**

Spare Part Numbers:  
147380SG . . . . . Flat Glass 380 Series  
1471022 . . . . . Mount suit 10-22mm  
1471625 . . . . . Mount suit 16-25mm

Approvals:  
Passenger LH side

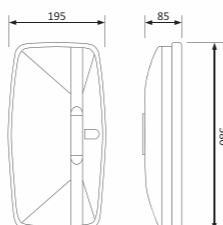

**PLASTIC SPLIT H380 R500 MARKER LEFT**

**147380SL12M**



**380 Split Flat & Convex | Split/Two-piece Mirror Heads**



Alternate Part Numbers:  
24V Version . . . . . 147380SL24M  
Heater Version . . . 147380SL12MH  
**Right Hand . . . . . 147380SR12M**

Spare Part Numbers:  
147380SG . . . . . Flat Glass 380 Series  
1471022 . . . . . Mount suit 10-22mm  
1471625 . . . . . Mount suit 16-25mm

Approvals:  
Passenger LH side

- Flat top, R500 Spotter
- Suits 19mm tubular arm
- 12V marker light
- Left Hand

**Features:**

- Two-piece split mirror, Left hand mount
- Top glass flat, bottom glass convex
- Top glass adjusts with the whole mirror, bottom glass adjusts independently
- Fits Hino Dutro, Toyota, UD and many universal applications

**Dimensions:**

H 380mm x D 85mm x W 195mm

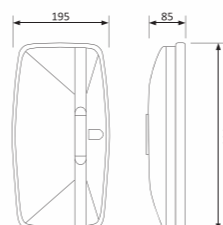

**PLASTIC SPLIT H420 R400 12V HEATED**

**147420S12H**



**420 Split Flat & Convex | Split/Two-piece Mirror Heads**



Alternate Part Numbers:  
147420S12H . . . . . Manual Split  
147420S24H . . . . . 24V Version

Spare Part Numbers:  
147420FG12H . . . Glass 12V Heated  
147420FG24H . . . Glass 24V Heated  
58326-24 . . . . . Dual Heater Switch  
1470018 . . . . . W/Coast 18" Adpt Tube  
1470016 . . . . . W/Coast 16" Adpt Tube

Approvals:  
E Approved, ADR 14-00

- Left Hand or Right Hand
- Clamp suits 19 - 28mm
- 12V
- Both mirrors manual
- Manual R400 spotter

**Features:**

- Universal LH or RH Split Manual mirror
- Suits European, Japanese, American & Australian vehicles
- Both mirrors manual and heated
- Universal clamp suits 19-28mm arm with 2 x adaptors provided
- Heater requires separate switch, 1.5m harness fitted

**Dimensions:**

H 420mm x D 75mm x W 190mm





**147430SL12H**

**PLASTIC SPLIT H430 R500 HEATED LEFT**



**430 Split Flat & Convex | Split/Two-piece Mirror Heads**



- Flat top, R500 Spotter
- Suits 19mm tubular arm
- 12V heater
- Left Hand

Alternate Part Numbers:  
24V Version . . . . . 147430SL24H  
Marker Version . . . 147430SL12MH  
**Right Hand . . . . . 147430SR12H**

**Features:**

- Two-piece mirror, Left hand mount
- Top glass flat, bottom glass convex
- Top glass adjusts with the whole mirror, bottom glass adjusts independently
- Fits Isuzu N and C series, Iveco Acco, UD trucks and other universal applications

**Spare Part Numbers:**

147430SG . . . . . Flat Glass 430 Series  
1471022 . . . . . Mount suit 10-22mm  
1471625 . . . . . Mount suit 16-25mm

Approvals:  
Passenger LH side

**Dimensions:**

H 430mm x D 85mm x W 200mm

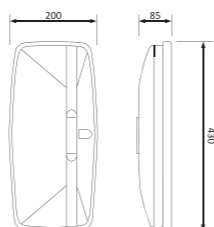

**PLASTIC SPLIT H430 R500 MARKER LEFT**

**147430SL12M**



**430 Split Flat & Convex | Split/Two-piece Mirror Heads**



Alternate Part Numbers:  
24V Version . . . . . 147430SL24M  
Heater Version . . . 147430SL12MH  
**Right Hand . . . . . 147430SR12M**

- Flat top, R500 Spotter
- Suits 19mm tubular arm
- 12V marker light
- Left Hand

**Features:**

- Two-piece mirror, Left hand mount
- Top glass flat, bottom glass convex
- Top glass adjusts with the whole mirror, bottom glass adjusts independently
- Fits Isuzu N and C series, Iveco Acco, UD trucks and other universal applications

**Spare Part Numbers:**

147430SG . . . . . Flat Glass 430 Series  
1471022 . . . . . Mount suit 10-22mm  
1471625 . . . . . Mount suit 16-25mm

Approvals:  
Passenger LH side

**Dimensions:**

H 430mm x D 85mm x W 200mm

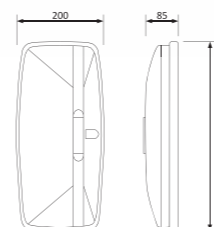

**147430SL**

**PLASTIC SPLIT H430 R500 LEFT**



**430 Split Flat & Convex | Split/Two-piece Mirror Heads**



- Flat top, R500 Spotter
- Suits 19mm tubular arm
- Left Hand

Alternate Part Numbers:  
**Right Hand . . . . . 147430SR**

**Features:**

- Two-piece mirror, Left hand mount
- Top glass flat, bottom glass convex
- Top glass adjusts with the whole mirror, bottom glass adjusts independently
- Fits Isuzu N and C series, Iveco Acco, UD trucks and other universal applications

**Spare Part Numbers:**

147430SG . . . . . Flat Glass 430 Series  
1471022 . . . . . Mount suit 10-22mm  
1471625 . . . . . Mount suit 16-25mm

Approvals:  
Passenger LH side

**Dimensions:**

H 430mm x D 85mm x W 200mm

**PLASTIC FLAT H232 W152**

**1441122**



**232 Flat Glass | Single Flat Mirror Heads**



Alternate Part Numbers:  
Suits Mirror . . . . . 1441011  
Suits Mirror . . . . . 1441012  
Suits Mirror . . . . . 1441020

- Plastic Body Flat Glass
- Suits door mirror bracket

**Features:**

- Flat glass, Plastic moulded body
- Suits utility mirror brackets, 8mm hole

**Spare Part Numbers:**

1441021 . . . . . Univ Contour 280 Arm  
1441032 . . . . . Univ Flat 340 Arm

**Dimensions:**

H 173mm x D 58mm x W 232mm

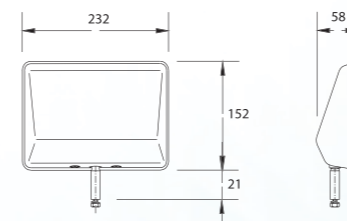

- See the mirror selection table (select by type and size) . . . . . Page M58
- See the Britax mounting bracket range . . . . . Page M47
- See the convex mirror and radius number explanation . . . . . Page M6
- See the Britax electric mirror range . . . . . Page M7
- See 12V or 24V heater and marker options . . . . . Page M58
- See the shatter-proof acrylic lens mirror range . . . . . Page M26

**7121-301**

**PLASTIC FLAT H195 W143 M16**



**195 Flat Glass | Single Flat Mirror Heads**

- Plastic Body Flat Glass
  - Clamp suits 16mm
- Features:**
- Flat glass, Plastic moulded body

**Dimensions:**  
H 195mm x D 61mm x W 143mm

Spare Part Numbers:  
1422000 . . . . . Universal Bracket  
1422080 . . . . . Bracket L Arm  
Z3002-068-10 . . . . . Glass Flat ( Pk 10 )  
7604-001-B . . . . . Adjustment Thumbwheel

Approvals:  
E Approved, ADR 14-00

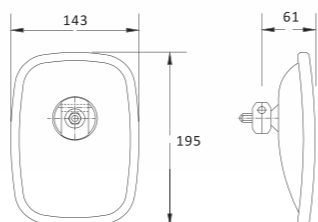

**7121-321**

**PLASTIC FLAT H195 W143 M22**



**195 Flat Glass | Single Flat Mirror Heads**

- Plastic Body Flat Glass
  - Clamp suits 10 - 22mm
- Features:**
- Flat glass, Plastic moulded body

**Dimensions:**  
H 195mm x D 97mm x W 143mm

Spare Part Numbers:  
1422000 . . . . . Universal Bracket  
1422080 . . . . . Bracket L Arm  
Z3002-068-10 . . . . . Glass Flat ( Pk 10 )

Approvals:  
E Approved, ADR 14-00

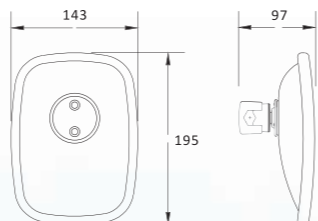

**PLASTIC FLAT H212 W124 M13**

**1412641**



**212 Flat Glass | Single Flat Mirror Heads**

- Plastic Body Flat Glass
  - Suits 12.7mm arm
- Features:**
- Flat glass, Plastic moulded body
  - Mirror head AH41

**Dimensions:**  
H 212mm x D 43mm x W 124mm

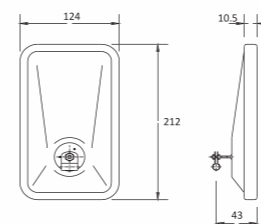

**PLASTIC FLAT H263 W160 M16**

**7181-301**



**263 Flat Glass | Single Flat Mirror Heads**

Spare Part Numbers:  
1422080 . . . . . Bracket L Arm  
Z4002-453-10 . . . . . Glass Flat ( Pk 10 )  
7604-001-B . . . . . Adjustment Thumbwheel

Approvals:  
E Approved, ADR 14-00

- Plastic Body Flat Glass
  - Clamp suits 16mm
- Features:**
- Flat glass, Plastic moulded body

**Dimensions:**  
H 263mm x D 75mm x W 160mm

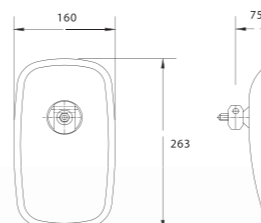

**7181-321**

**PLASTIC FLAT H263 W160 M22**



**263 Flat Glass | Single Flat Mirror Heads**

- Plastic Body Flat Glass
- Clamp suits 10 - 22mm

**Features:**

- Flat glass, Plastic moulded body

**Dimensions:**

H 263mm x D 97mm x W 160mm

Spare Part Numbers:  
1422080 . . . . . Bracket L Arm  
Z4002-453-10 . . . . Glass Flat ( Pk 10 )

Approvals:  
E Approved, ADR 14-00

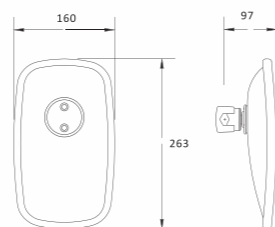

**7107-000**

**PLASTIC FLAT H270 W210 M22**



**270 Flat Glass | Single Flat Mirror Heads**

- Plastic Body Flat Glass
- Clamp suits 16 - 22mm

**Features:**

- Flat glass, Plastic moulded body

**Dimensions:**

H 270mm x D 100mm x W 210mm

Alternate Part Numbers:  
Acrylic Lens . . . . . 7107.602.A

Spare Part Numbers:  
7407-000-01 . . . . . Replacement Glass

Approvals:  
E Approved, ADR 14-00

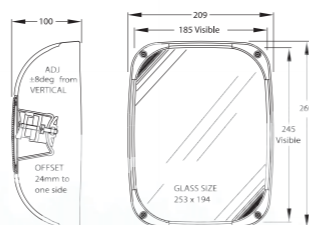

**PLASTIC FLAT H282 W174 M22**

**7112-023**

**282 Flat Glass | Single Flat Mirror Heads**

Spare Part Numbers:  
1422000 . . . . . Universal Bracket  
1422080 . . . . . Bracket L Arm  
Z4003-423-10 . . . . Flat Glass ( Pk 10 )  
4003-423-01 . . . . Flat Glass ( Pk 1 )

Approvals:  
E Approved, ADR 14-00

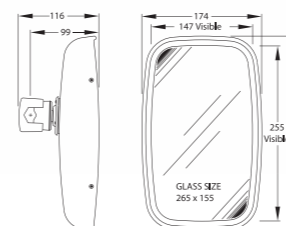

- Plastic Body Flat Glass
- Clamp suits 10 - 22mm

**Features:**

- Flat glass, Plastic moulded body

**Dimensions:**

H 282mm x D 116mm x W 174mm



**PLASTIC FLAT H380 W195 12V HEATED LEFT**

**147380FL12H**



**380 Flat Glass | Single Flat Mirror Heads**

Alternate Part Numbers:  
24V Version . . . . . 147380FL24H  
Marker Version . . . . 147380FL12MH  
Right Hand . . . . . 147380FR12H

Spare Part Numbers:  
147380FG . . . . . Flat Glass 380 Series  
1471022 . . . . . Mount suit 10-22mm  
1471625 . . . . . Mount suit 16-25mm

Approvals:  
Passenger LH side

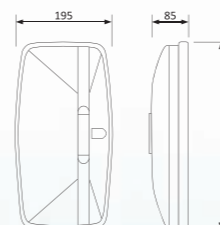

- Suits 19mm tubular arm
- 12V heater
- Left Hand

**Features:**

- One-piece flat mirror, Left hand mount
- Glass adjusts with the whole mirror
- Fits Hino Dutro, Toyota and many universal applications

**Dimensions:**

H 380mm x D 85mm x W 195mm



- See the mirror selection table (select by type and size) . . . . . Page M58
- See the Britax mounting bracket range . . . . . Page M47
- See the convex mirror and radius number explanation . . . . . Page M6
- See the Britax electric mirror range . . . . . Page M7
- See 12V or 24V heater and marker options . . . . . Page M58
- See the shatter-proof acrylic lens mirror range . . . . . Page M26

**147380FL12M**

**PLASTIC FLAT H380 W195 12V MARKER LEFT**



**380 Flat Glass | Single Flat Mirror Heads**

- Suits 19mm tubular arm
- 12V marker light
- Left Hand

**Features:**

- One piece flat mirror, Left hand mount
- Glass adjusts with the whole mirror
- Fits Hino Dutro, Toyota and many universal applications

**Dimensions:**

H 380mm x D 85mm x W 195mm

**Alternate Part Numbers:**

24V Version . . . . . 147380FL24M  
Heater Version . . . 147380FL12MH  
**Right Hand . . . . . 147380FR12M**

**Spare Part Numbers:**

147380FG . . . . . Flat Glass 380 Series  
1471022 . . . . . Mount suit 10-22mm  
1471625 . . . . . Mount suit 16-25mm

**Approvals:**

Passenger LH side

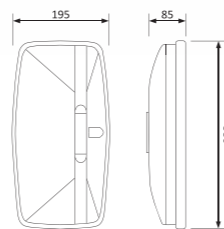

**PLASTIC FLAT H415 W225 M25**

**1423100**



**415 Flat Glass | Single Flat Mirror Heads**

**Alternate Part Numbers:**

7106.003.A . . . . . PMG Catalogue  
7106.005 . . . . . 24V Heated

**Spare Part Numbers:**

7400-001-05 . . . . . Flat Glass ( Pk 5 )

**Approvals:**

E Approved, ADR 14-00

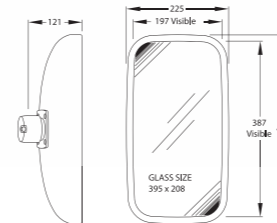

- Clamp suits 14 - 25mm

**Features:**

- Plastic moulded mirror head

**Dimensions:**

H 415mm x D 175mm x W 225mm



**147380F**

**PLASTIC FLAT H380 W195 M19 LEFT/RIGHT**



**380 Flat Glass | Single Flat Mirror Heads**

- Universal Left & Right Hand mount
- Suits 19mm tubular arm

**Features:**

- One-piece flat mirror
- Glass adjusts with the whole mirror
- Fits Hino Dutro, Toyota and many universal applications

**Dimensions:**

H 380mm x D 85mm x W 195mm

**Alternate Part Numbers:**

Convex Version . . . 147380C

**Spare Part Numbers:**

147380FG . . . . . Flat Glass 380 Series  
1471022 . . . . . Mount suit 10-22mm  
1471625 . . . . . Mount suit 16-25mm

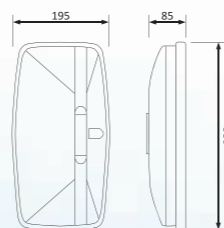

**PLASTIC FLAT H430 W200 12V HEATED LEFT**

**147430FL12H**



**430 Flat Glass | Single Flat Mirror Heads**

**Alternate Part Numbers:**

24V Version . . . . . 147430FL24H  
Marker Version . . . 147430FL12MH  
**Right Hand . . . . . 147430FR12H**

**Spare Part Numbers:**

147430FG . . . . . Flat Glass 430 Series  
1471022 . . . . . Mount suit 10-22mm  
1471625 . . . . . Mount suit 16-25mm

**Approvals:**

Passenger LH side

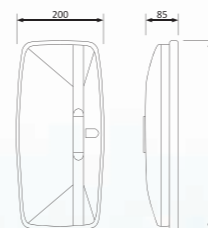

- Suits 19mm tubular arm
- 12V heater
- Left Hand

**Features:**

- One piece flat mirror, Left hand mount
- Glass adjusts with the whole mirror
- Fits Hino Ranger Pro and many other universal applications

**Dimensions:**

H 430mm x D 85mm x W 200mm



**147430FL12M**

**PLASTIC FLAT H430 W200 12V MARKER LEFT**



**430 Flat Glass | Single Flat Mirror Heads**

- Suits 19mm tubular arm
- 12V marker light
- Left Hand

**Features:**

- One piece flat mirror, Left hand mount
- Glass adjusts with the whole mirror
- Fits Hino Ranger Pro and many other universal applications

**Dimensions:**

H 430mm x D 85mm x W 200mm

Alternate Part Numbers:  
24V Version . . . . . 147430FL24M  
Heater Version . . . 147430FL12MH  
**Right Hand . . . . . 147430FR12M**

Spare Part Numbers:  
147430FG . . . . . Flat Glass 430 Series  
1471022 . . . . . Mount suit 10-22mm  
1471625 . . . . . Mount suit 16-25mm

Approvals:  
Passenger LH side

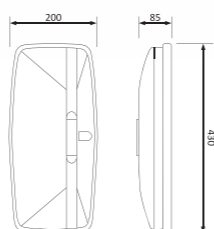

**147430F**

**PLASTIC FLAT H430 W200 LEFT/RIGHT**



**430 Flat Glass | Single Flat Mirror Heads**

- Universal Left & Right Hand mount
- Suits 19mm tubular arm

**Features:**

- One-piece flat mirror, Left or right hand mount
- Glass adjusts with the whole mirror
- Fits Hino Ranger Pro and many universal applications

**Dimensions:**

H 430mm x D 85mm x W 200mm

Alternate Part Numbers:  
Convex Version . . . 147430C

Spare Part Numbers:  
147430FG . . . . . Flat Glass 430 Series  
1471022 . . . . . Mount suit 10-22mm  
1471625 . . . . . Mount suit 16-25mm

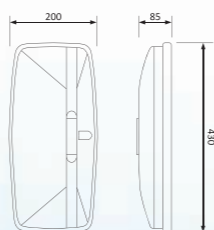

**PLASTIC FLAT H444 W208 M20**

**7818-000F**



Spare Part Numbers:  
1422000 . . . . . Universal Bracket  
7418-000F . . . . . Replacement Glass

Approvals:  
E Approved, ADR 14-00

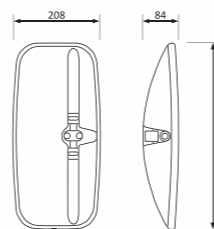

**444 Flat Glass | Single Flat Mirror Heads**

- Plastic Body Flat Glass
- Clamp suits 14 - 20mm

**Features:**

- Plastic moulded body

**Dimensions:**

H 444mm x D 84mm x W 208mm



**STEEL FLAT H286 W162 M13**

**1412647**

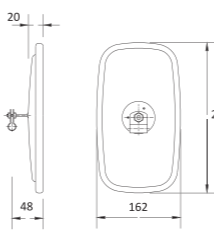

**286 Flat Glass | Single Flat Mirror Heads**

- Steel Body Flat Glass
- Suits 12.7mm arm
- Mirror head AH41

**Features:**

- Flat glass
- Coated steel body

**Dimensions:**

H 286mm x D 48mm x W 162mm



# MIRRORS ACRYLIC REFLECTORS

## Britax Acrylic Reflector Design

Designed to be interchangeable with existing Britax glass mirrors, the acrylic reflectors offer enhanced impact resistance and increased visibility in wet conditions.

Ideal for agricultural, construction equipment and mechanical handling applications where glass breakage is a common occurrence, or where the mirror is likely to be subject to excess vibration or shock. The reflectors are also ideal in situations where glass fracture could cause a safety risk.

Most mirror breakages are the result of an impact on the front of the mirror case, rather than a direct hit to the mirror surface. Having said this, the Britax range of acrylic reflectors can withstand a direct impact by a 300 gram steel 'bullet' dropped from a height of 1,400mm without resulting damage. Glass on the other hand will shatter at only 500mm.

Acrylic reflectors pass the ECE Reg 46 pendulum test without breaking. Again, glass mirrors shatter when subjected to this same test.

Britax acrylic reflectors will crack under very severe impact, but will not shatter. Any shards or fractures are retained by a self-adhesive backing pad and the mirror image is only slightly impaired.

## Hard Coating for Scratch Resistance and Durability

The outer surface of the reflector is covered with a super hydrophilic coating that prevents water droplets from forming, offering clearer vision. The surface also repels dust particles, and is resistant to chemical and organic materials commonly found in the agricultural and construction environment.

The special formula acrylic and hard coating provide a surface capable of withstanding the ASTM D3363-00 Pencil Test using an 8H pencil. This hard surface makes the acrylic reflectors resistant to dust abrasion, especially when wiped in a dry state. A polycarbonate material will mark with a 2H pencil under the same test conditions and will scratch more easily when wiped in a dry state.

## Performance, Interchangeability and Approvals

Britax acrylic reflector performance is equal to its glass equivalent. The special formula acrylic has enhanced ultra violet and anti-yellowing properties. The acrylic material is produced using a patented injection plus compression process ensuring the reflectors demonstrate superior optical performance. This construction process also means that the mirrors can be used in environments from -40°C up to 60°C.

The acrylic reflectors are directly interchangeable with existing glass mirrors enabling simple upgrading to acrylic and ensuring ease of replacement in the future.

All Britax acrylic reflectors are approved to the ECE Regulation 46 Pendulum Test and also the EEC Directives 71/127 and 88/321.



## PLASTIC CONVEX H195 R1200 M22

7120-321



### R1200 Convex Glass | Single Convex Mirror Heads

Alternate Part Numbers:  
Acrylic Version . . . 7120.620.A

Spare Part Numbers:  
1422000 . . . . . Universal Bracket  
1422080 . . . . . Bracket L Arm  
Z4002-498-10 . . . Glass Cnx ( Pk 10 )

Approvals:  
E Approved, ADR 14-00

- Convex R1200
- Clamp suits 10 - 22mm

- Features:**
- R1200 Convex glass
  - Plastic moulded body

**Dimensions:**  
H 195mm x D 97mm x W 143mm

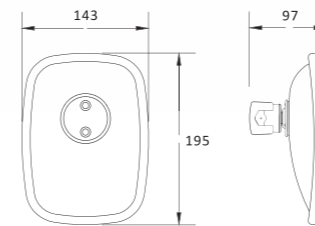

## PLASTIC CONVEX H195 R1200 M22 ACRYLIC

7120.620.A



### R1200 Convex Acrylic | Single Convex Mirror Heads

Alternate Part Numbers:  
Glass Version . . . . 7120-321

Approvals:  
ECE 46, ASTM D3363-00, ADR 14-00



- R1200 convex
- Clamp suits 10 - 22mm
- Shatter-proof mirror

- Features:**
- Acrylic mirror material, OEM quality reflection
  - Hydrophilic coating, prevents water droplets from forming
  - High resistance to breakage and vibration
  - Suitable for heavy duty applications such as earthmoving, mining, agricultural, heavy transport
  - As fitted to JCB and Case tractors

**Dimensions:**  
H 195mm x D 45mm x W 140mm

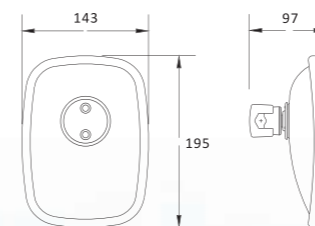

**7120-301**

**PLASTIC CONVEX H195 R1200 W143 M16**



**R1200 Convex Glass | Single Convex Mirror Heads**



- Convex R1200
- Clamp suits 16mm

Spare Part Numbers:  
1422000 . . . . . Universal Bracket  
1422080 . . . . . Bracket L Arm  
Z4002-498-10 . . . . . Glass Cnx ( Pk 10 )  
7604-001-B . . . . . Adjustment Thumbwheel

**Features:**

- R1200 Convex glass
- Plastic moulded body

**Dimensions:**

H 195mm x D 61mm x W 143mm

Approvals:  
E Approved, ADR 14-00

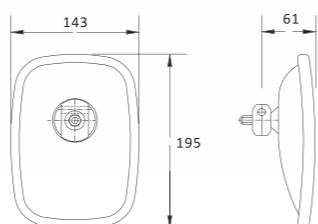

**4003-189**

**PLASTIC CONVEX H210 R1200 HEAD**



**R1200 Convex Glass | Single Convex Mirror Heads**



- Black plastic moulded mirror head only
- Suits 4003-161 mount

Alternate Part Numbers:  
Fits Mirror . . . . . 4003-161

**Features:**

- Head only, 27mm ball socket
- Mirror head is adjustable via a ball pivot

Spare Part Numbers:  
Z4003-412-10 . . . . . Glass Cnx ( Pk 10 )

**Dimensions:**

H 210mm x D 51mm x W 140mm

Approvals:  
E Approved, ADR 14-00

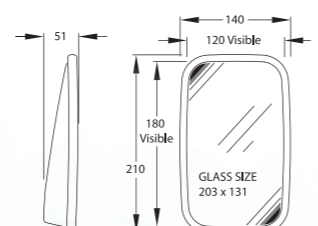

**PLASTIC CONVEX H260 R1200 M22 ACRYLIC**

**7182.620.A**



Alternate Part Numbers:  
7182-321 . . . . . Glass Version

- R1200 convex
- Clamp suits 10 - 22mm
- Shatter-proof mirror

Approvals:  
ECE 46, ASTM D3363-00, ADR 14-00

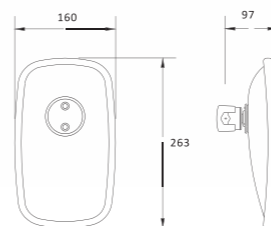

**R1200 Convex Acrylic | Single Convex Mirror Heads**

**Features:**

- Plastic mirror material, OEM quality reflection
- Hydrophilic coating, prevents water droplets from forming
- High resistance to breakage and vibration
- Suitable for heavy duty applications such as earthmoving, mining, agricultural, heavy transport

**Dimensions:**

H 263mm x D 97mm x W 160mm



**PLASTIC CONVEX H263 R1200 M16**

**7182-301**



Spare Part Numbers:  
1422080 . . . . . Bracket L Arm  
Z4002-496-10 . . . . . Glass Cnx ( Pk 10 )  
7604-001-B . . . . . Adjustment Thumbwheel

- Plastic Body Convex R1200 Glass
- Clamp suits 16mm

Approvals:  
E Approved, ADR 14-00

**Features:**

- R1200 Convex glass
- Plastic moulded body

**Dimensions:**

H 263mm x D 75mm x W 160mm

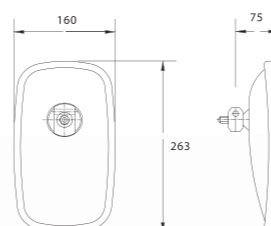

**R1200 Convex Glass | Single Convex Mirror Heads**



- See the mirror selection table (select by type and size) . . . . . Page M58
- See the Britax mounting bracket range . . . . . Page M47
- See the convex mirror and radius number explanation . . . . . Page M6
- See the Britax electric mirror range . . . . . Page M7
- See 12V or 24V heater and marker options . . . . . Page M58
- See the shatter-proof acrylic lens mirror range . . . . . Page M26

7182-321

PLASTIC CONVEX H263 R1200 M22



**R1200 Convex Glass | Single Convex Mirror Heads**

- Plastic Body Convex R1200 Glass
- Clamp suits 10 - 22mm

Spare Part Numbers:  
Z4002-496-10. . . . Glass Cnx ( Pk 10 )

**Features:**

- R1200 Convex glass
- Plastic moulded body

**Approvals:**

E Approved, ADR 14-00

**Dimensions:**

H 263mm x D 97mm x W 160mm

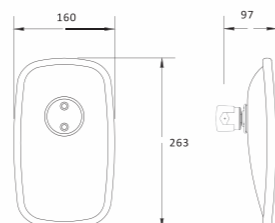

7180-301

PLASTIC CONVEX H263 R1800 M16



**R1800 Convex Glass | Single Convex Mirror Heads**

- Plastic Body Convex R1800 Glass
- Clamp suits 16mm

Spare Part Numbers:  
Z4002-488-10. . . . Glass Cnx ( Pk 10 )  
7604-001-B. . . . . Adjustment Thumbwheel

**Features:**

- R1800 Convex glass
- Plastic moulded body

**Approvals:**

E Approved, ADR 14-00

**Dimensions:**

H 263mm x D 75mm x W 160mm

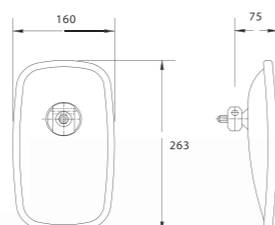

PLASTIC CONVEX H270 R1200 M22

7107-002



**R1200 Convex Glass | Single Convex Mirror Heads**

Alternate Part Numbers:  
Acrylic Version . . . 7107.602.A

- Plastic Body Convex R1200 Glass
- Clamp suits 16 - 22mm

**Spare Part Numbers:**

7412-001-05. . . . . Glass Cnx ( Pk 5 )

**Features:**

- R1200 Convex glass
- Plastic moulded body

**Approvals:**

E Approved, ADR 14-00

**Dimensions:**

H 270mm x D 100mm x W 210mm

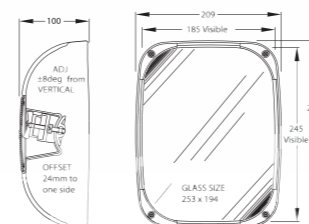

PLASTIC CONVEX H270 R1200 M22 ACRYLIC

7107.602.A

**R1200 Convex Acrylic | Single Convex Mirror Heads**

Alternate Part Numbers:  
7107-002 . . . . . Glass Version

- R1200 convex
- Clamp suits 16 - 22mm
- Shatter-proof mirror

**Approvals:**

ECE 46, ASTM D3363-00, ADR 14-00

**Features:**

- Plastic mirror material, OEM quality reflection
- Hydrophilic coating, prevents water droplets from forming
- High resistance to breakage and vibration
- Suitable for heavy duty applications such as earthmoving, mining, agricultural, heavy transport

**Dimensions:**

H 270mm x D 100mm x W 210mm

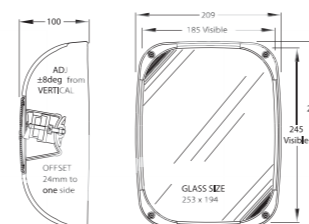



**7107-001**

**PLASTIC CONVEX H270 R1800 M22**



**R1800 Convex Glass | Single Convex Mirror Heads**



- Plastic Body Convex R1800 Glass
- Clamp suits 16 - 22mm

Alternate Part Numbers:  
Acrylic Version . . . 7107.601.A

**Features:**

- R1800 Convex glass
- Plastic moulded body

Spare Part Numbers:  
7418-005-05 . . . . . Glass Cnx ( Pk 5 )

**Dimensions:**

H 270mm x D 100mm x W 210mm

Approvals:  
E Approved, ADR 14-00

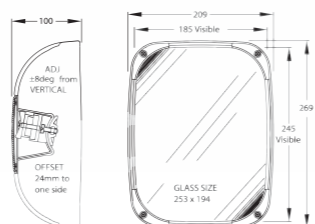

**7107.601.A**

**PLASTIC CONVEX H270 R1800 M22 ACRYLIC**



**R1800 Convex Acrylic | Single Convex Mirror Heads**



- R1800 Convex
- Clamp suits 16 - 22mm
- Shatter-proof mirror

Alternate Part Numbers:  
7107-001 . . . . . Glass Version

**Features:**

- Plastic mirror material, OEM quality reflection
- Hydrophilic coating, prevents water droplets from forming
- High resistance to breakage and vibration
- Suitable for heavy duty applications such as earthmoving, mining, agricultural, heavy transport

Approvals:  
ECE 46, ASTM D3363-00, ADR 14-00



**Dimensions:**

H 270mm x D 100mm x W 210mm

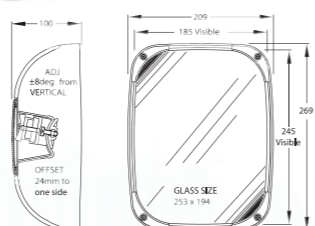

**PLASTIC CONVEX H282 R1800 M22**

**7112-022**



**R1800 Convex Glass | Single Convex Mirror Heads**

Spare Part Numbers:  
1422000 . . . . . Universal Bracket  
1422080 . . . . . Bracket L Arm  
Z4003-422-10 . . . . . Glass Cnx ( Pk 10 )  
4003-422-01 . . . . . Glass Cnx ( Pk 1 )

- Plastic Body Convex R1800 Glass
- Clamp suits 10 - 22mm

**Features:**

- R1800 Convex glass
- Plastic moulded body

**Dimensions:**

H 282mm x D 116mm x W 174mm

Approvals:  
E Approved, ADR 14-00

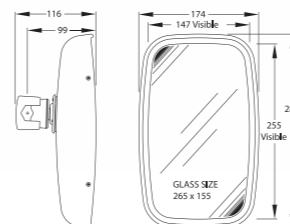

**PLASTIC CONVEX H282 R450 M22**

**7112-020**



**R450 Convex Glass | Single Convex Mirror Heads**

Spare Part Numbers:  
1422000 . . . . . Universal Bracket  
1422080 . . . . . Bracket L Arm  
Z4003-420-05 . . . . . Glass Cnx ( Pk 5 )  
4003-420-01 . . . . . Glass Cnx ( Pk 1 )

- Plastic Body Convex R450 Glass
- Clamp suits 10 - 22mm

**Features:**

- R450 Convex glass
- Plastic moulded body

**Dimensions:**

H 282mm x D 116mm x W 174mm

Approvals:  
E Approved, ADR 14-00

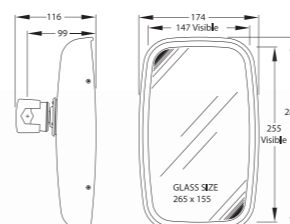

- See the mirror selection table (select by type and size) . . . . . Page M58
- See the Britax mounting bracket range . . . . . Page M47
- See the convex mirror and radius number explanation . . . . . Page M6
- See the Britax electric mirror range . . . . . Page M7
- See 12V or 24V heater and marker options . . . . . Page M58
- See the shatter-proof acrylic lens mirror range . . . . . Page M26

**7132.601.A**

**PLASTIC CONVEX H328 R1800 M25 ACRYLIC**



**R1800 Convex Acrylic | Single Convex Mirror Heads**



- Plastic Body Convex R1800 Glass
- Clamp suits 16 - 25mm

Alternate Part Numbers:  
7132.509. . . . . Glass Version  
7132.506. . . . . 12V Heated  
7132.507. . . . . 24V Heated

**Features:**

- R1800 Convex glass
- Plastic moulded body

Spare Part Numbers:  
1422000 . . . . . Universal Bracket  
1422080 . . . . . Bracket L Arm  
7418.006.05 . . . . Glass Cnx ( Pk 5 )

**Dimensions:**

H 328mm x D 120mm x W 238mm

Approvals:  
E Approved, ADR 14-00

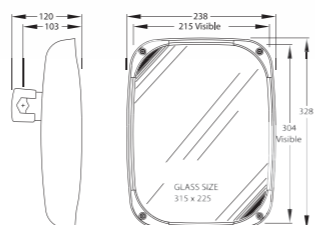

**7131.600.A**

**PLASTIC CONVEX H330 R1800 M22 ACRYLIC**



**R1800 Convex Acrylic | Single Convex Mirror Heads**



- R1800 convex mirror
- Clamp suits 19 - 22mm
- Shatter-proof mirror
- Slot back

Spare Part Numbers:  
7604-001-B. . . . . Adjustment Thumbwheel

**Features:**

- Plastic mirror material, OEM quality reflection
- Hydrophilic coating, prevents water droplets from forming
- High resistance to breakage and vibration
- Suitable for heavy duty applications such as earthmoving, mining, agricultural, heavy transport

Approvals:  
ECE 46, ASTM D3363-00, ADR 14-00

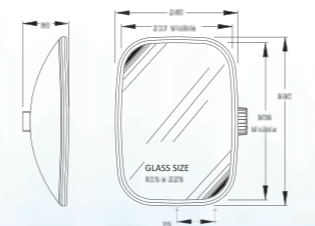

**Dimensions:**

H 330mm x D 90mm x W 240mm



**PLASTIC CONVEX H330 R1800 M22 ACRYLIC**

**7131.601.A**



**R1800 Convex Acrylic | Single Convex Mirror Heads**

Spare Part Numbers:  
7604-001-B. . . . . Adjustment Thumbwheel

- R1800 convex mirror
- Clamp suits 19 - 22mm
- Shatter-proof mirror

**Approvals:**

ECE 46, ASTM D3363-00, ADR 14-00

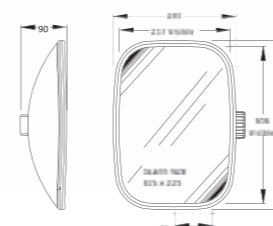

**Features:**

- Plastic mirror material, OEM quality reflection
- Hydrophilic coating, prevents water droplets from forming
- High resistance to breakage and vibration
- Suitable for heavy duty applications such as earthmoving, mining, agricultural, heavy transport

**Dimensions:**

H 330mm x D 90mm x W 240mm



**PLASTIC CONVEX H358 R1800 M16 HEATED**

**Z4003-187**



**R1800 Convex Glass | Single Convex Mirror Heads**

Spare Part Numbers:  
Z4003.401.05 . . . . Glass Cnx ( Pk 5 )

- Plastic Body Convex R1800 Glass
- Clamp suits 16mm
- 24V Heated Glass
- 0.6A@24V

**Approvals:**

E Approved, ADR 14-00

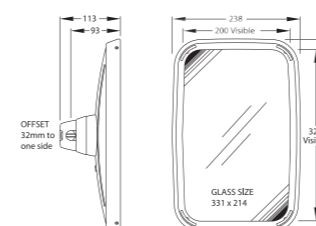

**Features:**

- R1800 Convex glass
- Plastic moulded body

**Dimensions:**

H 358mm x D 113mm x W 238mm



**147380C**

**PLASTIC CONVEX H380 R1800 M19**



**R1800 Convex | Single Convex Mirror Heads**



- Universal Left & Right Hand mount
- Suits 19mm tubular arm

Alternate Part Numbers:  
Flat Version . . . . . 147380F

**Features:**

- One piece mirror
- Left or right hand mount
- Convex Glass adjusts with the whole mirror
- Fits Hino Dutro, Toyota and many universal applications

Spare Part Numbers:  
147430CG . . . . . Convex Glass 380 Series  
1471022 . . . . . Mount suit 10-22mm  
1471625 . . . . . Mount suit 16-25mm

**Dimensions:**  
H 380mm x D 85mm x W 195mm

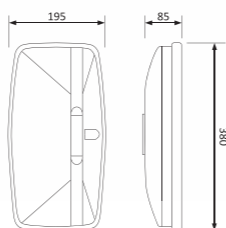

**PLASTIC CONVEX H430 R1800 M19**

**147430C**



**R1800 Convex Glass | Single Convex Mirror Heads**

Alternate Part Numbers:  
Flat Version . . . . . 147430F

- Universal Left & Right Hand mount
- Suits 19mm tubular arm

Spare Part Numbers:  
147430CG . . . . . Convex Glass 430 Series  
1471022 . . . . . Mount suit 10-22mm  
1471625 . . . . . Mount suit 16-25mm

- Features:**
- One piece mirror
  - Left or right hand mount
  - Convex Glass adjusts with the whole mirror
  - Fits Hino Dutro, Toyota and many universal applications

**Dimensions:**  
H 430mm x D 85mm x W 200mm

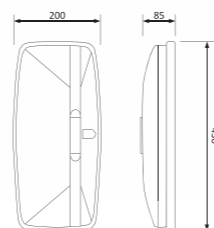

**1423125**

**PLASTIC CONVEX H415 R1800 M25**



**R1800 Convex Glass | Single Convex Mirror Heads**

- R1800 Convex Glass
- Clamp suits 14 - 25mm

Alternate Part Numbers:  
7106.000.A . . . . . PMG Catalogue  
7106.002 . . . . . 24V Heated

**Features:**

- Plastic moulded mirror head

Spare Part Numbers:  
1423325 . . . . . Convex Glass ( Pk 1 )  
Z4002.475.05 . . . . Convex Glass ( Pk 5 )  
Z4002.687.05 . . . . 24V Heated Glass ( Pk 5 )

**Dimensions:**  
H 415mm x D 175mm x W 225mm

Approvals:  
E Approved, ADR 14-00

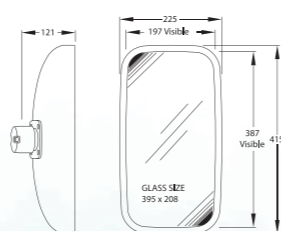

**PLASTIC CONVEX H444 R1200 M20**

**7818-000C**



**R1200 Convex Glass | Single Convex Mirror Heads**

Spare Part Numbers:  
1422000 . . . . . Universal Bracket  
7418-000C . . . . . Replacement Glass

- Plastic Body Convex R1200 Glass
- Clamp suits 14 - 20mm

Approvals:  
E Approved, ADR 14-00

**Features:**

- Plastic moulded body

**Dimensions:**  
H 444mm x D 84mm x W 208mm

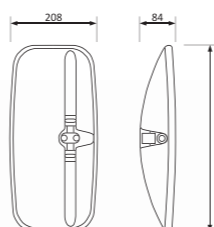

- See the mirror selection table (select by type and size) . . . . . Page M58
- See the Britax mounting bracket range . . . . . Page M47
- See the convex mirror and radius number explanation . . . . . Page M6
- See the Britax electric mirror range . . . . . Page M7
- See 12V or 24V heater and marker options . . . . . Page M58
- See the shatter-proof acrylic lens mirror range . . . . . Page M26

1441017

EXTERIOR REVERSING CONVEX R400 H172 W142



**R400 Convex | Spotter and Reversing Mirrors**



- Reversing safety
- Clamp on 300mm arm



**Features:**

- Easy to install (no holes required to be drilled to install unit)
- Angle adjustable
- Wide and safety view
- Suitable for vans, wagons and 4WDs
- Caravan or trailer aid



**Dimensions:**

H 172mm x W 142mm

1441910

INTERIOR FLAT REAR VIEW MIRROR



**Reversing Mirror | Spotter and Reversing Mirrors**



- Flat glass day/night
- Interior pedestal mount

**Features:**

- Black plastic moulded mirror head
- Interior rear view mirror: day/night

**Dimensions:**

H 58mm x D 10mm x W 250mm

1441016

RECTANGULAR CONVEX R200 H103 W140 SELF ADHESIVE



**R200 Convex | Spotter and Reversing Mirrors**



- Plastic D140mm Spotter
- Self-adhesive back



**Features:**

- Fits directly onto the surface of an existing mirror
- Assists with blind spots and reverse parking



**Dimensions:**

H 103mm x D 15mm x W 140mm

RECTANGULAR CONVEX R300 H103 W210 S/STEEL

7803-000



**R300 Convex | Spotter and Reversing Mirrors**

Alternate Part Numbers:  
7803-000 . . . . . Box

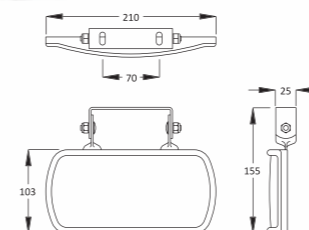

- S/Steel housing
- Over Door Spotter, Also suitable for Ski Boats

**Features:**

- Supplied with pivoting mounting bracket
- Suit over door or restricted space application for blind spot vision or rear view Ski Boat spotter
- Stainless steel housing & finish

**Dimensions:**

H 103mm x D 25mm x W 210mm



RECTANGULAR CONVEX R300 H150 W110 S/STEEL

1421015



**R300 Convex | Spotter and Reversing Mirrors**



- Stainless Steel housing
- Angle bracket Spotter

**Features:**

- Supplied with tubular mount and angle bracket and separate clamp
- Stainless steel housing & finish

**Dimensions:**

H 150mm x D 95mm x W 110mm



RECTANGULAR CONVEX R300 H150 W110 STEEL

1421014



**R300 Convex | Spotter and Reversing Mirrors**



- Metal housing
- Angle bracket Spotter

**Features:**

- Supplied with tubular mount and angle bracket and separate clamp
- Metal housing black finish

**Dimensions:**

H 150mm x D 95mm x W 110mm



1441014

ROUND CONVEX R150 D50 SELF ADHESIVE



R150 Convex | Spotter and Reversing Mirrors

- Plastic D50mm Spotter
- 50mm Self adhesive

**Features:**

- Fits directly onto the surface of an existing mirror
- Assists with blind spots and reverse parking

**Dimensions:**

H 50mm x D 15mm



1441015

ROUND CONVEX R300 D100 SELF ADHESIVE



R300 Convex | Spotter and Reversing Mirrors

- Plastic D100mm Spotter
- 100mm Self adhesive

**Features:**

- Fits directly onto the surface of an existing mirror
- Assists with blind spots and reverse parking

**Dimensions:**

H 100mm x D 15mm



1441026

ROUND CONVEX R300 D190 S/STEEL

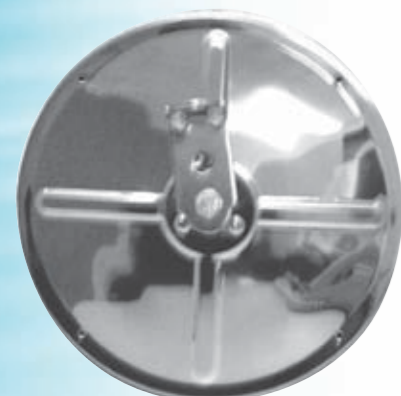

R300 Convex | Spotter and Reversing Mirrors

- Round Stainless Steel D190
- Angle bracket Spotter

**Features:**

- Supplied with tubular mount and angle bracket and separate clamp
- Stainless Steel housing and finish

**Dimensions:**

H 190mm x D 85mm



1441025

ROUND CONVEX R300 D190 STEEL



R300 Convex | Spotter and Reversing Mirrors

- Round Steel D190
- Angle bracket Spotter

**Features:**

- Supplied with tubular mount and angle bracket and separate clamp
- Metal housing black finish

**Dimensions:**

H 190mm x D 85mm



ROUND CONVEX R300 D216 S/STEEL

R300 Convex | Spotter and Reversing Mirrors

- Round Stainless Steel D216
- Angle bracket Spotter

**Features:**

- Supplied with tubular mount and angle bracket and separate clamp
- Stainless Steel housing and finish

**Dimensions:**

H 216mm x D 90mm

ROUND CONVEX R300 D216 STEEL

R300 Convex | Spotter and Reversing Mirrors

- Round Steel D216
- Angle bracket Spotter

**Features:**

- Supplied with tubular mount and angle bracket and separate clamp
- Metal housing black finish

**Dimensions:**

H 216mm x D 90mm

1441031

ROUND CONVEX R400 D125 S/STEEL



R400 Convex | Spotter and Reversing Mirrors



- Round Stainless Steel D125
- Angle bracket Spotter



**Features:**

- Supplied with tubular mount and angle bracket and separate clamp
- Stainless Steel housing and finish

**Dimensions:**

H 125mm x D 80mm



1441030

ROUND CONVEX R400 D125 STEEL



R400 Convex | Spotter and Reversing Mirrors



- Round Steel D125
- Angle bracket Spotter



**Features:**

- Supplied with tubular mount and angle bracket and separate clamp
- Metal housing black finish

**Dimensions:**

H 125mm x D 80mm



1441024

ROUND CONVEX R400 D150 S/STEEL



R400 Convex | Spotter and Reversing Mirrors



- Round Stainless Steel D150
- Angle bracket Spotter



**Features:**

- Supplied with tubular mount and angle bracket and separate clamp
- Stainless Steel housing and finish

**Dimensions:**

H 150mm x D 85mm



ROUND CONVEX R400 D150 STEEL

1441023



R400 Convex | Spotter and Reversing Mirrors



- Round Steel D150
- Angle bracket Spotter

**Features:**

- Supplied with tubular mount and angle bracket and separate clamp
- Metal housing black finish

**Dimensions:**

H 150mm x D 85mm



SQUARE CONVEX R400 H195 W195 PLASTIC HEATED

147195



R400 Convex | Spotter and Reversing Mirrors

- Square Plastic Integrated Bracket M282
- Suit 28mm arm
- Heated 24V

**Features:**

- Convex heated spotter 24 volt
- Plastic moulded body
- Suit Mercedes Actros, Atego
- Suit 28mm mounting bar

**Dimensions:**

H 195mm x D 55mm x W 195mm



PLASTIC CONVEX H210 R1200 M165

4003-161



Door R1200 Convex | Light Commercial and 4WD Mirrors

Alternate Part Numbers:  
7182-161 . . . . . Alternate No

Spare Part Numbers:  
4003-189 . . . . . Mirror Head  
Z4003-412-10 . . . . . Glass Cnx ( Pk 10 )

- Universal left or right mount
- Door mount arm L 165mm

**Features:**

- 27mm Pivoting ball joint mirror mount
- Black plastic moulded, coated metal swing arm
- Mounting block 2 x M6 x 1.0, 60mm CTC

**Dimensions:**

H 210mm x D 50mm x W 140mm

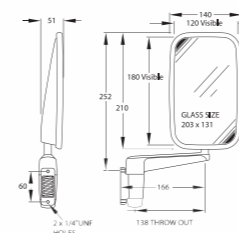

**1441011**

**STEEL FLAT H232 W152 M280**

**Door Mount Single | Light Commercial and 4WD Mirrors**



- Single mirror
- Extended arm length of 280mm

Alternate Part Numbers:  
Set x 2 . . . . . 1441022

**Features:**

- High corrosion resistant properties
- Hinged door brackets
- Heavy duty pivot point hardware includes nylon washers, spring washers for pivot point rigidity and zinc coated fittings
- Reversible design to suit contour of vehicle cabin

Spare Part Numbers:  
1441122 . . . . . Replacement Mirror Head  
1441021 . . . . . Single Bracket 280mm  
1421190 . . . . . Door Support Kit

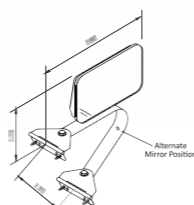

**Dimensions:**

H 340mm x D 93mm x W 280mm

**STEEL FLAT H232 W152 M340**

**1441012**

**Door Mount Single | Light Commercial and 4WD Mirrors**



Alternate Part Numbers:  
Set x 2 . . . . . 1441033

- Single mirror
- Extended arm length of 340mm

Spare Part Numbers:  
1441122 . . . . . Replacement Mirror Head  
1441032 . . . . . Single Bracket 340mm  
1421190 . . . . . Door Support Kit

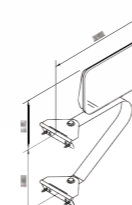

**Features:**

- High corrosion resistant properties
- Hinged door brackets
- Heavy duty pivot point hardware includes nylon washers, spring washers for pivot point rigidity and zinc coated fittings
- Replaceable plastic moulded mirror head

**Dimensions:**

H 350mm x D 93mm x W 340mm

**1441022**

**STEEL FLAT H232 W152 M280 PAIR**

**Door Mount Pair | Light Commercial and 4WD Mirrors**



- Galvanised powder coated steel swing arm and mounting bracket
- Extended arm length of 280mm

Spare Part Numbers:  
1441122 . . . . . Replacement Mirror Head  
1441021 . . . . . Single Bracket 280mm  
1421190 . . . . . Door Support Kit  
1441011 . . . . . Single Complete Mirror

**Features:**

- High corrosion resistant properties
- Hinged door brackets
- Heavy duty pivot point hardware includes nylon washers, spring washers for pivot point rigidity and zinc coated fittings
- Reversible design to suit contour of vehicle cabin
- Includes plastic moulded mirror head part number: 1441122
- Suits contour door

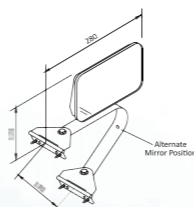

**Dimensions:**

H 340mm x D 93mm x W 280mm

**STEEL FLAT H232 W152 M340 PAIR**

**1441033**

**Door Mount Pair | Light Commercial and 4WD Mirrors**



Spare Part Numbers:  
1441122 . . . . . Replacement Mirror Head  
1441032 . . . . . Single Bracket 340mm  
1421190 . . . . . Door Support Kit  
1441012 . . . . . Single Complete Mirror

- Galvanised powder coated steel swing arm and mounting bracket
- Extended arm length of 340mm

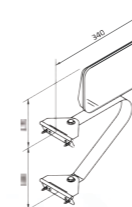

**Features:**

- High corrosion resistant properties
- Hinged door brackets
- Heavy duty pivot point hardware includes nylon washers, spring washers for pivot point rigidity and zinc coated fittings
- Includes plastic moulded mirror head part number: 1441122
- Suits flat door

**Dimensions:**

H 350mm x D 93mm x W 340mm

- See the mirror selection table (select by type and size) . . . . . Page M58
- See the Britax mounting bracket range . . . . . Page M47
- See the convex mirror and radius number explanation . . . . . Page M6
- See the Britax electric mirror range . . . . . Page M7
- See 12V or 24V heater and marker options . . . . . Page M58
- See the shatter-proof acrylic lens mirror range . . . . . Page M26



1472755

PLASTIC CLAMP-ON SPLIT R600 TOWING



Split Flat & R600 Convex | Towing Mirrors



- Split flat & R600 convex towing mirror
- Clamps to door mirror, both mirrors adjustable



Features:

- Clamps on to the side mirror, light weight
- Split mirror flat/convex, both adjustable
- Improved blind spot vision
- Installs easily with adjustable straps
- Adjust clamp height using toothed interlocking clamp
- Ideal side mirror min 145mm, max 227mm
- Fitting instructions included



Dimensions:

H 130mm x D 70mm x W 180mm

1441020

STEEL HEAVY DUTY FLAT TOWING MIRROR



Strap-on Towing Mirror | Towing Mirrors



- Strap-on universal towing mirror
- Strap-on to door top and bottom

Spare Part Numbers:  
1441122 . . . . . Replacement Mirror Head  
1441006 . . . . . Strap for Plastic Outer

Features:

- Fast and easy to fit and remove
- Fully adjustable strong arms, W 320 - 480mm
- Ratchet adjustable hold down strap, door H 1M
- Resists vibration when mounted
- Strong ball joint on mirror head, D 8mm mount
- Larger area glass for better vision
- Commercial mirror head for low noise, replaceable
- Bottom hook available for outer plastic panels
- Suits 4WDs and cars, mount base W 170mm



Dimensions:

H 1200mm x D 170mm x W 320 - 480mm

1441006

STEEL HOOK & STRAP FOR PLASTIC OUTER



Towing Mirrors



- Steel hook & strap for plastic outer

Alternate Part Numbers:  
Suits Mirror . . . . . 1441020

Features:

- Strap and hook to suit doors with outer plastic panel, eg. Prado, late Landcruiser, Honda, Hyundai, Kluger, etc.
- Suits heavy duty mirror assembly 1441020

Dimensions:

H 50mm x W 50mm

ADAPTOR 10 - 22MM 147380/430 SERIES

1471022



Adaptor | Mirror Arms and Brackets



- Fibre reinforced moulded
- Clamp suits 10 - 22mm

Features:

- Enables 147380 & 147430 mirror heads to be fitted to 10 - 22mm mounting arms
- Universal fibre reinforced clamp

Dimensions:

H 55mm x D 50mm x W 50mm



ADAPTOR 16 - 25MM 147380/430 SERIES

1471625



Adaptor | Mirror Arms and Brackets



- Fibre reinforced clamp
- Clamp suits 16 - 25mm

Features:

- Enables 147380 & 147430 mirror heads to be fitted to 16 - 25mm mounting arms
- Universal fibre reinforced clamp

Dimensions:

H 75mm x D 55mm x W 55mm



ADJUSTMENT THUMBWHEEL

7604-001-B



Mirror Arms and Brackets

Spare Part Numbers:  
Suffix -301 . . . . . Suits Mirror Types 7120 & 1 & 31 . . . Suits Mirror Types 7180 & 1 & 2 . . . Suits Mirror Types 7250 & 70 series . . Suits Arm Types

- Adjustment thumbwheel

Features:

- Makes manual adjustment of mirrors and arms very easy
- Plastic moulded body
- Fits M8 x 1.25 mounting studs

Dimensions:

H 33mm x D 55mm





1410591

ARM ASSEMBLY

Mirror Arms and Brackets



- Galvanised powder coated steel frame and mounting brackets

Features:

- High corrosion resistant properties
- Adjustable in length 350 - 540mm
- Mirror arm adjusts telescopically
- Suits universal mirror heads

Dimensions:

H 230 to 310mm x D 10mm x W 350 to 540mm



1422080

BRACKET HEAVY DUTY

Mirror Arms and Brackets



- Galvanised powder coated steel frame and mounting brackets
- 16mm diameter arm

Features:

- High corrosion resistant properties
- Solid arm with 90 degree bend
- Ideal for small commercial vehicles and fork lifts
- Suits small to medium mirror heads
- Mirror heads sold separately

Dimensions:

H 230mm x D 16mm x W 200mm

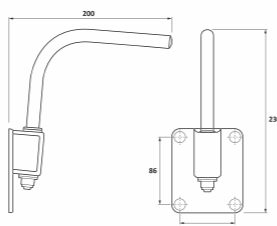

1441021

BRACKET LIGHT TRUCK 280MM

Mirror Arms and Brackets



- Galvanised powder coated aluminium arm
- Extended arm length of 280mm

Spare Part Numbers:  
1441122 . . . . . Mirror Head to Suit

Features:

- High corrosion resistant properties
- Hinged top and bottom mounting brackets to suit cabin profile
- Heavy duty pivot point hardware includes nylon washers, spring washers for pivot point rigidity and zinc coated fittings
- Reversible designed mirror arm to suit vehicle contour

Dimensions:

H 170mm x D 93mm x W 280mm



BRACKET LIGHT TRUCK 340MM

1441032

Mirror Arms and Brackets



Spare Part Numbers:  
1441122 . . . . . Mirror Head to Suit

- Galvanised powder coated aluminium arm
- Extended arm length of 340mm

Features:

- High corrosion resistant properties
- Hinged top and bottom mounting brackets to suit cabin profile
- Heavy duty pivot point hardware includes nylon washers, spring washers for pivot point rigidity and zinc coated fittings

Dimensions:

H 180mm x D 93mm x W 340mm



C ADAPTOR BRACKET SUIT WEST COAST ADJUST

1442502

Mirror Arms and Brackets



- C Frame with tags
- SP2502

Features:

- Powder coated black steel tube
- 19mm dia adjustable 430 to 700mm
- Suits West Coast mirror heads

Dimensions:

H 430 to 700mm x D 19mm x W 400mm



C ADAPTOR BRACKET SUIT WEST COAST FIXED

1473000

380 and 430 Series | Mirror Arms and Brackets



Spare Part Numbers:  
1422000 . . . . . Universal Bracket

- West Coast Adaptor Bracket to suit Japanese style mirror head fitment

Features:

- A fixed length 19mm mounting bar that allows the fitment of the 380 and 430 series Japanese flat and split mirrors to be fitted on standard West Coast mounting brackets

Dimensions:

H 480mm x D 19mm x W 220mm



1441189

CLAMP ASSEMBLY FLAT



**Mirror Arms and Brackets**



- Clamp assembly Flat



**Features:**

- Allows fitment to 16mm tubular frames
- Suits West Coast mirror heads
- Suits HL series spot & flood light mounting

**Dimensions:**

H 20mm x D 70mm x W 25mm

1441190

CLAMP ASSEMBLY FLAT



**Mirror Arms and Brackets**



- Clamp assembly Flat



**Features:**

- Allows fitment to 19mm tubular frames
- Suits West Coast mirror heads
- Suits HL series spot & flood light mounting

**Dimensions:**

H 20mm x D 70mm x W 25mm

1441185

CLAMP ASSEMBLY RIGHT ANGLE



**Mirror Arms and Brackets**



- Clamp assembly Right Angle



**Features:**

- Allows sideways fitment to 16mm tubular frames
- Suits West Coast mirror heads

**Dimensions:**

H 22mm x D 47mm x W 112mm

1441187

CLAMP ASSEMBLY RIGHT ANGLE



**Mirror Arms and Brackets**



- Clamp assembly Right Angle



**Features:**

- Allows sideways fitment to 19mm tubular frames
- Suits West Coast mirror heads

**Dimensions:**

H 22mm x D 47mm x W 112mm

DOOR MOUNTING & REINFORCEMENT PLATE

1421190



**Mirror Arms and Brackets**



- Door mounting & reinforcement plate

**Features:**

- To add door support and simplify mounting for mirror brackets
- Powder coated black steel, inc mounting screws
- 4 threaded holes, 70mm outer Ctrs to hold plate, 43mm inner Ctrs for mirror bracket

**Dimensions:**

H 7mm x D 120mm x W 47mm



EXTENDABLE ARM FIXED PIVOT M19

7270-050



**Extendable M19 | Mirror Arms and Brackets**

Alternate Part Numbers:  
7270-550 . . . . . Arm with Cable

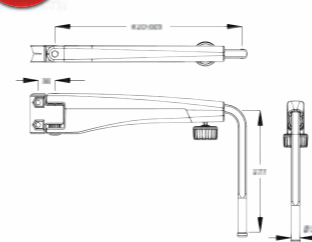

- Fixed Pivot Adjustment
- 19mm diameter arm
- LH or RH mounting

**Features:**

- Extendable 19mm arm 420 - 665mm
- Multi fixed 45 deg pivot points, attach either upward or downward
- Galvanised powder coated steel
- Mounting block 2 x M10, 50mm CTC

**Dimensions:**

H 277mm x D 19mm x W 420-665mm



EXTENSION ARM

1422001



**Mirror Arms and Brackets**

- Extension arm ( Qty 1 )

**Features:**

- Length 245mm

**Dimensions:**

H 245mm x D 16mm



7219-010

MIDIBRAC L BRACKET FIXED PIVOT M19



Midibrac L M19 | Mirror Arms and Brackets

- Fixed Pivot Adjustment
- 19mm diameter arm
- LH or RH mounting

Alternate Part Numbers:  
7219-001 . . . . . PMG Catalogue

Features:

- Solid L shape 19mm arm
- Multi fixed 45 deg pivot points, attach either upward or downward
- Galvanised powder coated steel
- Mounting block 2 x M10, 50mm CTC

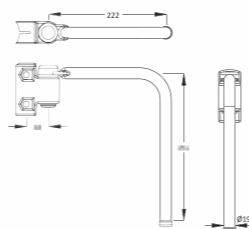

Dimensions:

H 252mm x D 19mm x W 222mm



7200-007

MIDIBRAC N BRACKET SPRING PIVOT M16



Midibrac N M16 | Mirror Arms and Brackets

- Spring Loaded Pivot Adjustment
- 16mm diameter arm
- LH or RH mounting

Alternate Part Numbers:  
7200-007 . . . . . PMG Catalogue

Features:

- Solid N shape 16mm arm
- Multi position, attach either upward or downward
- Galvanised powder coated steel
- Mounting block 2 x M6 x 1.0, 60mm CTC

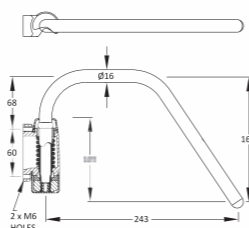

Dimensions:

H 160mm x D 16mm x W 243mm



7200-058

MIDIBRAC S BRACKET SPRING PIVOT M16



Midibrac S M16 | Mirror Arms and Brackets

- Spring Loaded Pivot Adjustment
- 16mm diameter arm
- LH or RH mounting

Alternate Part Numbers:  
7200-025 . . . . . PMG Catalogue

Features:

- Solid S shape 16mm arm
- Multi position, attach either upward or downward
- Galvanised powder coated steel
- Mounting block 2 x M6 x 1.0, 60mm CTC

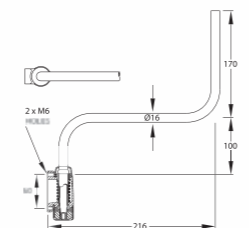

Dimensions:

H 270mm x D 16mm x W 216mm



MIDIBRAC U BRACKET SPRING PIVOT M16

7200-061



Midibrac U M16 | Mirror Arms and Brackets

Alternate Part Numbers:  
7200-050 . . . . . PMG Catalogue

- Spring Loaded Pivot Adjustment
- 16mm diameter arm
- LH or RH mounting

Features:

- Solid U shape 16mm arm
- Multi position, attach either upward or downward
- Galvanised powder coated steel
- Mounting block 2 x M6 x 1.0, 60mm CTC

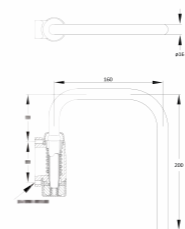

Dimensions:

H 200mm x D 16mm x W 170mm



STAY ASSEMBLY M12 SP1182

1441182



SS Support Arm | Mirror Arms and Brackets

- Stay assembly M12 SP1182, Single arm only

Features:

- Stainless Steel 16mm extendable arm
- Adjustable length 360mm - 500mm

Dimensions:

H 360 to 500mm x D 16mm



W/COAST BRACKET H ADJUST W240

1422006



W/Coast Mount | Mirror Arms and Brackets

Spare Part Numbers:  
1421100 . . . . . Suits 18" Heads  
1421106 . . . . . Suits 16" Heads  
1421131 . . . . . Suits 14.5" Heads  
1421101 . . . . . Suits 11" Heads  
1421190 . . . . . Door Mount Plate

- Galvanised powder coated steel frame and mounting brackets

Features:

- Suits West Coast Mirror heads and other universal applications
- Adjustable height for 11" to 18"
- Galvanized black powder coated
- Universal mounting brackets, position locking
- Attractive retail packaging

Dimensions:

H 490 to 635mm x D 19/16mm x W 240mm

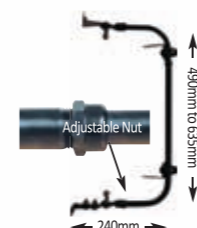

1422026

W/COAST BRACKET H&W ADJUST W340 - 430



W/Coast Mount | Mirror Arms and Brackets



- Galvanised powder coated steel frame and mounting brackets

**Features:**

- Suits West Coast Mirror heads and other universal applications
- Adjustable bow & height for 11" to 18"
- Galvanized black powder coated
- Universal mounting brackets, position locking
- Attractive retail packaging

**Dimensions:**

H 480 to 630mm x D 19/16mm x W 340 to 430mm

- Spare Part Numbers:
- 1421100 . . . . . Suits 18" Heads
  - 1421106 . . . . . Suits 16" Heads
  - 1421131 . . . . . Suits 14.5" Heads
  - 1421101 . . . . . Suits 11" Heads
  - 1421190 . . . . . Door Mount Plate



1422000

W/COAST BRACKET W/BRACE H&W ADJUST W445 - 545



W/Coast Mount | Mirror Arms and Brackets



- Galvanised powder coated steel frame and mounting brackets

**Features:**

- Suits West Coast Mirror heads and other universal applications
- Adjustable bow & height for 11" to 18"
- Adjustable brace length 510-720mm
- Galvanized black powder coated
- Universal mounting brackets
- Attractive retail packaging

**Dimensions:**

H 430 to 635mm x D 19/16mm x W 445 to 545mm

- Spare Part Numbers:
- 1421100 . . . . . Suits 18" Heads
  - 1421106 . . . . . Suits 16" Heads
  - 1421131 . . . . . Suits 14.5" Heads
  - 1421101 . . . . . Suits 11" Heads
  - 1421190 . . . . . Door Mount Plate
  - 1473000 . . . . . 19mm Single D Arm

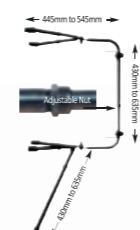

LOOM WITH MULTI-CONTROL SWITCH (DUAL)

1423872



Euro Harness | Mirror Wiring Kits and Heaters

- Spare Part Numbers:
- 1423190 . . . . . Suits this Mirror
  - 1423191 . . . . . Suits this Mirror

- Suit European 6 Pin Plugs
- 12/24V

**Features:**

- Length 2 metres ea, 6 pin Euro plugs
- Suits electric mirrors
- Suits 12 and 24V mirror heads
- Mounting hole H 36mm, W 36mm

**Dimensions:**

H 42mm x D 55mm x W 42mm



LOOM WITH MULTI-CONTROL SWITCH (DUAL)

147HARNESS



Universal Dual Harness | Mirror Wiring Kits and Heaters

- Spare Part Numbers:
- 147420SE12H . . . Suits this Mirror
  - 147420SE24H . . . Suits this Mirror

- Universal Applications
- 12/24V

**Features:**

- Length 2 metres each side
- Suits electric mirrors
- Suits 12 and 24V mirror heads

**Dimensions:**

H 42mm x D 58mm x W 35mm



LOOM WITH MULTI-CONTROL SWITCH (SINGLE)

1423870



Mirror Wiring Kits and Heaters

- Spare Part Numbers:
- 1423190 . . . . . Suits this Mirror
  - 1423191 . . . . . Suits this Mirror

- 12/24V

**Features:**

- Length 2 metres
- Suits electric mirrors
- Suits 12V and 24V mirror heads



1423631

MIRROR HEATER ELEMENT



W/Coast Heater | Mirror Wiring Kits and Heaters



- PTC material
- 12/24V
- 0.7A@12V
- 1.4A@24V

Features:

- Self adhesive heater element, dual voltage 12/24V
- Suits West Coast heads (see spare parts)
- 750mm cable

Dimensions:

H 318mm x W 133mm

Spare Part Numbers:

- 1421100 . . . . . Suits this Mirror
- 1421158 . . . . . Suits this Mirror
- 1422655 . . . . . Suits this Mirror
- 1421106 . . . . . Suits this Mirror
- 1421166 . . . . . Suits this Mirror
- 1421131 . . . . . Suits this Mirror
- 1421133 . . . . . Suits this Mirror

1423635

MIRROR HEATER ELEMENT



Mirror Wiring Kits and Heaters



- 24V

Features:

- Suits European mirror heads (see spare parts)
- Heater element 24V

Dimensions:

H 390mm x W 192mm

Spare Part Numbers:

- 1423100 . . . . . Suits this Mirror
- 1423125 . . . . . Suits this Mirror
- 7818-000C . . . . . Suits this Mirror
- 7818-000F . . . . . Suits this Mirror

# MIRRORS RETAIL PACKAGING AND DISPLAYS

Britax Mirrors Retail Packaging

Britax commercial mirror heads, brackets, assemblies, towing mirrors and self-adhesive spotters are available in attractive and practical retail packaging. The packaging features bold Britax colours and logos to make your Britax mirror range stand out on the display. Part numbers and descriptions are clear to make finding the right part easy for staff and customers. Detailed assembly and installation instructions are also included as part of this total retail solution.



Britax Mirrors Retail Displays

Britax can provide a range of retail display options including display signage by request. Contact your Britax sales representative for more information on available display and merchandising options.



# MIRRORS SECTIONS

Missed something on your first look?  
Here's a list of the key sections in this catalogue:

- See the mirror selection table (select by type and size) . . . . . Page M58
- See the Britax mounting bracket range . . . . . Page M47
- See the convex mirror and radius number explanation . . . . . Page M6
- See the Britax electric mirror range . . . . . Page M7
- See 12V or 24V heater and marker options . . . . . Page M58
- See the shatter-proof acrylic lens mirror range . . . . . Page M26







Automotive Equipment

**Britax Automotive Equipment Pty Ltd**  
Freecall 1800 025 921 | Freefax 1800 659 936

79 Crockford Street Northgate Queensland 4013  
PO Box 775 Virginia Queensland 4014  
P 07 3000 1900 | F 07 3000 1999  
sales@britaxae.com.au

[www.britaxae.com.au](http://www.britaxae.com.au)

